

Znips London **Identity Manual**



Znips London

75 Wilton Road, London SW1V 1DE

Telephone: +44 (0)20 7828 6688

Znips London **Identity Manual**

This identity manual outlines how to apply the Znips London identity in the correct and originally intended way. It is important that everyone involved with the company is familiar with these guidelines and uses them consistently in every aspect of communication.

Contents

Logo

- 1.1 Logo
- 1.2 Logo Sizes
- 1.3 Logo Colours
- 1.4 Logo Freezone
- 1.5 Logo Positioning 1
- 1.6 Logo Positioning 2
- 1.7 Logo Positioning Don'ts
- 1.8 Logo Patterns
- 1.9 Logo Don'ts

Typography

- 2.1 Authorised Typefaces
- 2.2 Typographic Basics

Stationery

- 3.1 Business Card
- 3.2 Letterhead
- 3.3 Compliment Slip
- 3.4 Fax Sheet

Retail

- 4.1 Signage
- 4.2 Window Vinyl
- 4.3 Aprons

Credits & Support

Logo

1.1 Logo

The Znips logo must be clearly visible wherever it is used. It is essential that the logo is used correctly and consistently in all media of communication. It must never be redrawn, modified or enclosed in a box or frame.

The logo should be applied in the authorised colour palette, in black and white or specified monochrome colours. It should never be reproduced in any other colour.

When the name 'Znips London' is used in addition to the logo, it should be written in lowercase with initial capitals, ie: Znips London.

Variations in the use of the logo will undermine the impact and consistency of the overall design.

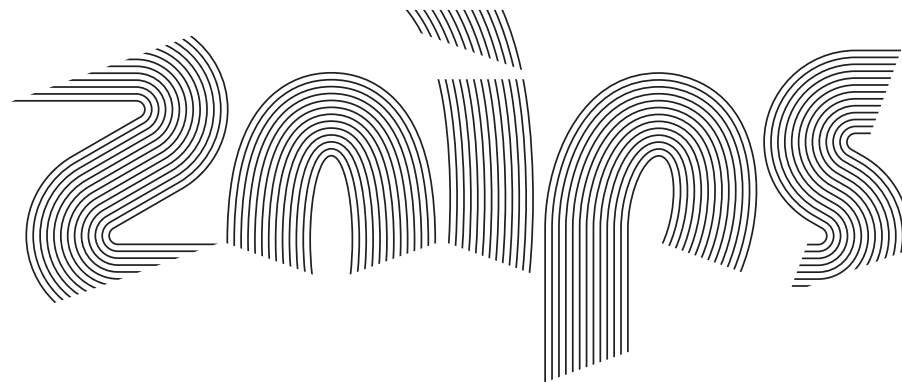

1.2 Logo Sizes

The Zlips logo comes in three main sizes. When the logo is reproduced in small sizes, the lines and the spaces between the lines could appear too tight. Also when the logo is reproduced very large the lines will become too thick. For these reasons three variations of the logo are available.

It is important that the correct logo is used at the correct size, otherwise printing or display problems may occur.



Small: Used when the width is 40mm or less.

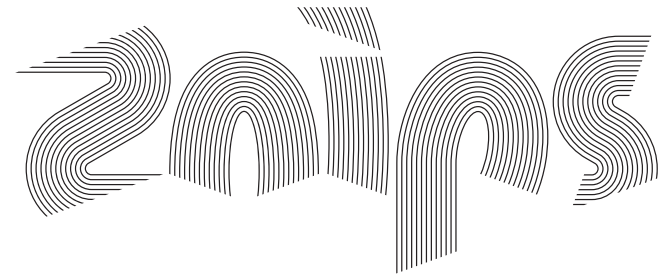

Medium: Used when the width is 40mm or more.



Large: Used when the width is 400mm or more. (Notice above when printed too small it does not display correctly.)

1.3 Logo Colours

Colour is an integral part of the Zrips identity. The logo should always appear in an authorised colour palette. Users must identify which colour should be used for which application. The palette presents a consistent and recognisable company image across all media of communication.

Text should be printed in Pantone 445 or black. For laser printers and fax sheets black is recommended. The selected colours can also be used as a solid background, for headlines and subheadings or as an accent colour to highlight important parts of a text.

If it is not possible to print the logo in a 4 colour process or as individual Pantone colours it is recommended to use the logo in the specified monochrome colour.



Pantone 144
C:0 / M:48 / Y:100 / K:0
R:242 / G:141 / B:47



Pantone 445
C:5 / M:0 / Y:10 / K:68
R:85 / G:90 / B:87



Pantone Cool Grey 5
C:0 / M:0 / Y:0 / K:29
R:188 / G:191 / B:195



Black
C:0 / M:0 / Y:0 / K:100
R:0 / G:0 / B:0

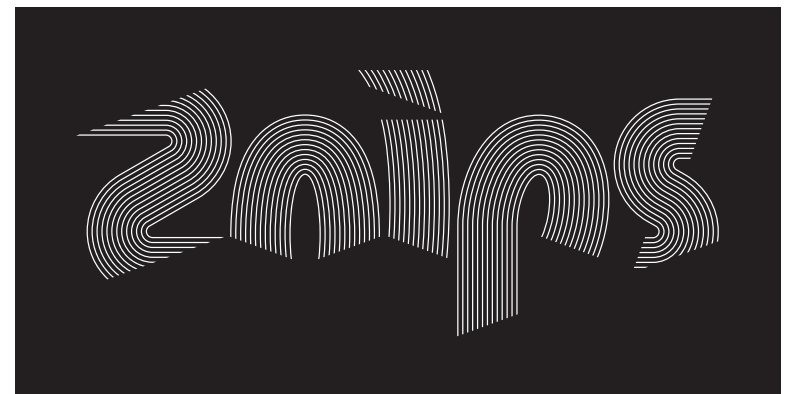
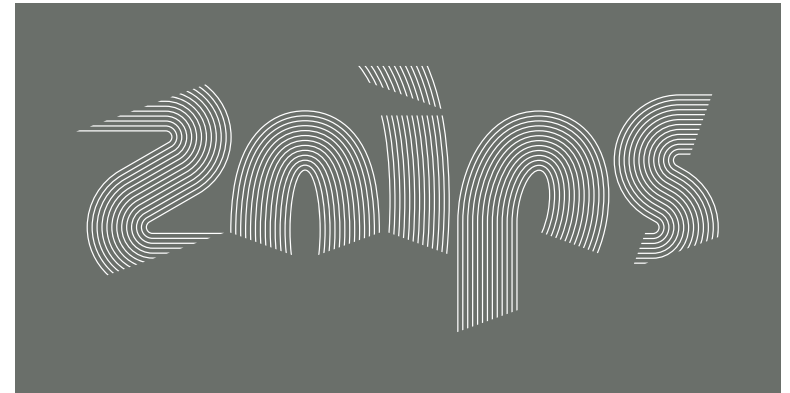

1.4 Logo Freezone

Whenever the Znips logo is used close to text or images, a freezone (or area of isolation) should be kept around the logo. A certain amount of space around the logo enhances its appearance and visibility.

This freezone is a guide only and should be used at the discretion of the designer, taking into account the size and application of the item being designed.

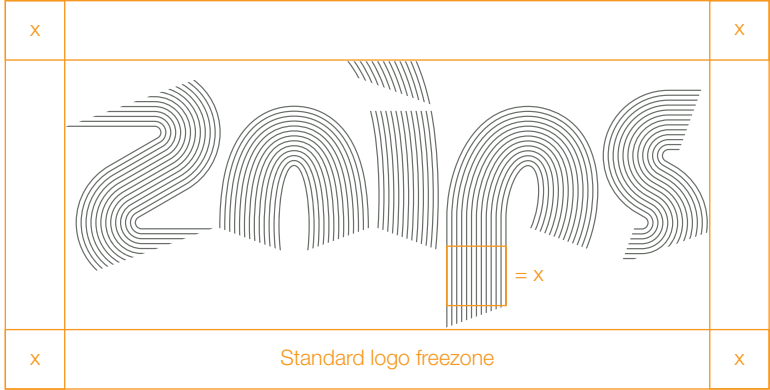

1.5–1.7 Logo Positioning

Although the logo can be used very loosely, it is important that some rules should be followed.

Depending on where the logo appears should determine how the logo is used, for instance on a official document the logo should be used in a more formal way. The following pages show various applications of the logo.

it is important that if the logo is used bleeding off the page that it still reads as 'Znips' and not for instance 'nips'.

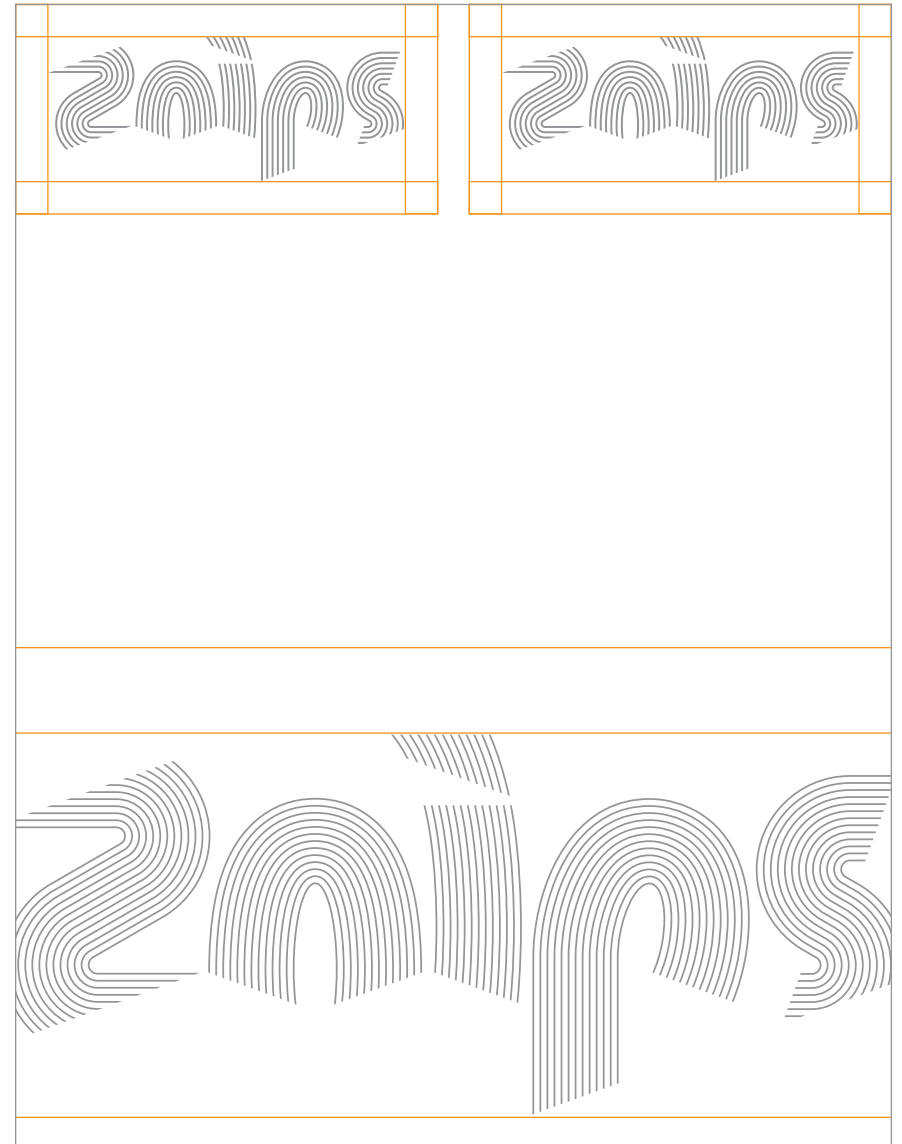

Formal use of the logo adhering to the freezone.

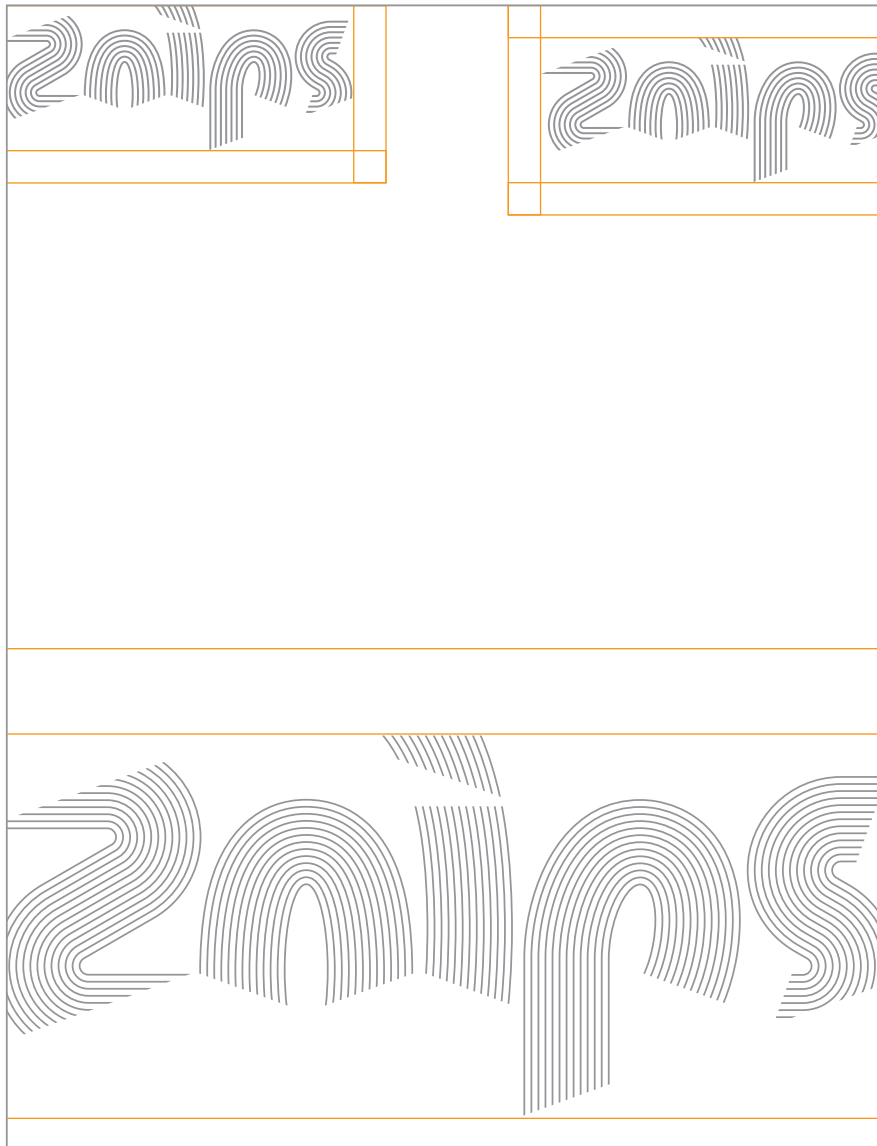

Cropping which does not interfere with the reading of the logo.

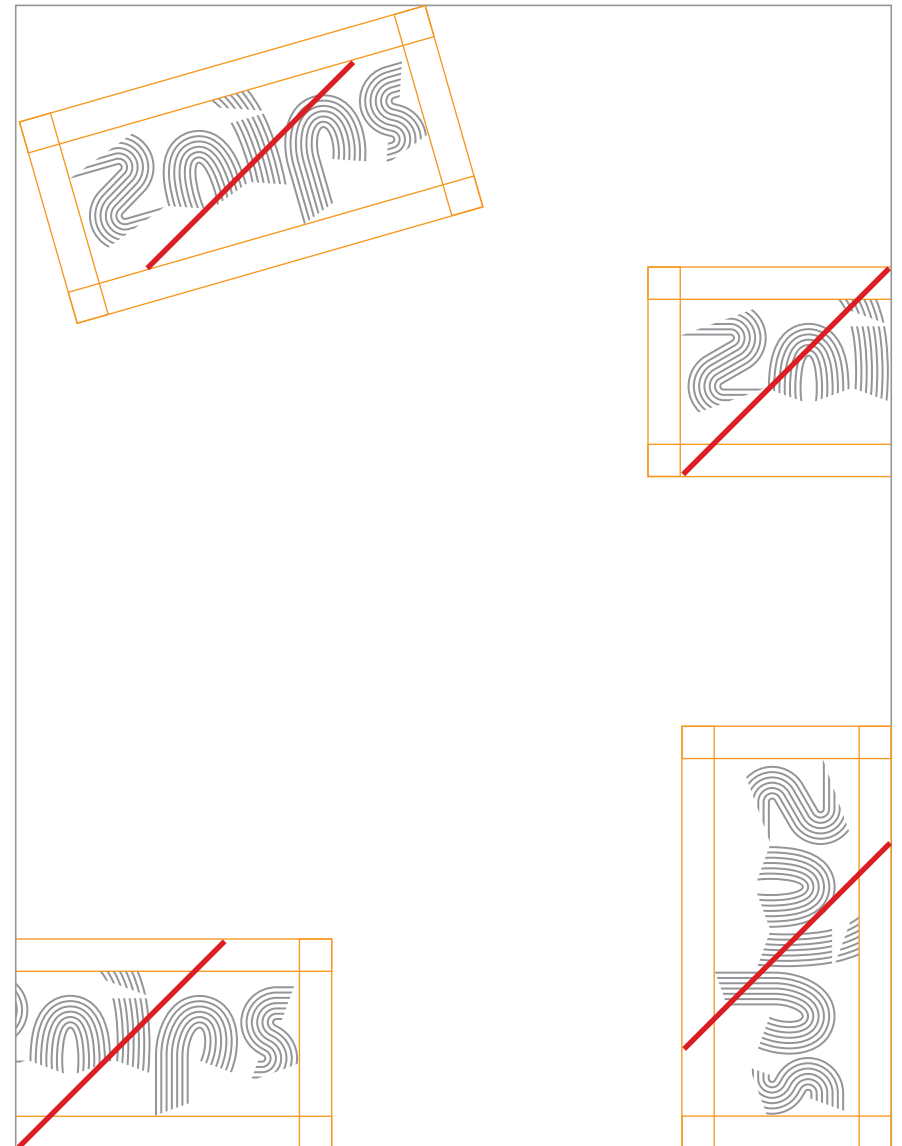

The logo can be used bravely but do not crop whole letters from the logo.

1.8 Logo Patterns

The Zhips logo can be used as a pattern for decoration. There are no real rules as such, just overlap the logo elements until happy with the composition.

Any of the colour combinations can be used but it should be kept to two colours.

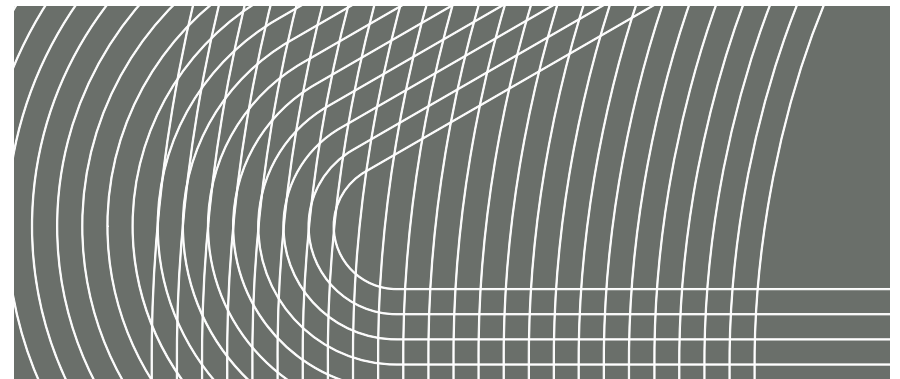
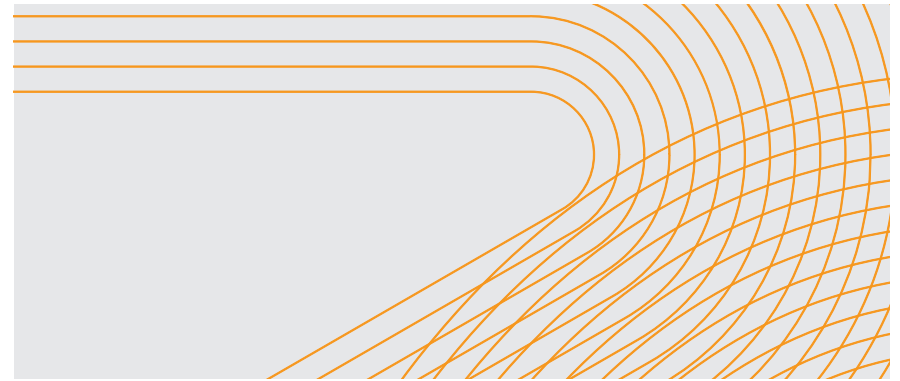

1.9 Logo Don'ts

The Zlips logo must be clearly visible wherever it is used. It is essential that the logo is used correctly and consistently in all media of communication. It must never be redrawn, modified or enclosed in a box or frame.

Variations in the use of the logo will undermine the impact and consistency of the identity.

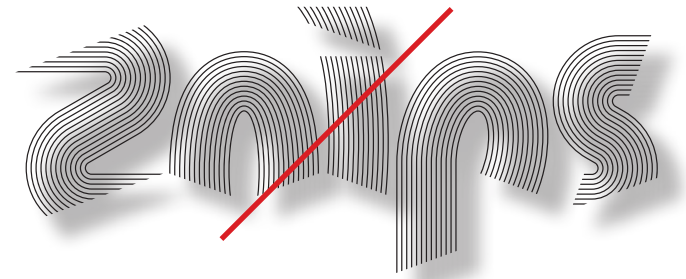

Don't add effects to the logo.



Don't stretch or distort the logo.

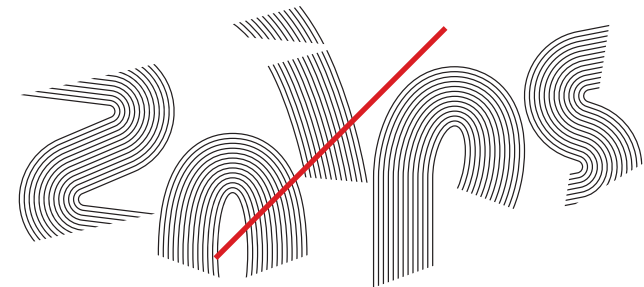

Don't rearrange the logo.

Typography

The background features a solid orange color with a complex pattern of thin white lines. These lines form a grid of curved, overlapping shapes that create a sense of depth and movement, resembling a stylized topographical map or a series of concentric, intersecting arcs.

2.1 Authorised Typefaces

It is recommended to use the Helvetica Neue family for all printed matter. Helvetica Neue is a functional and widely available font. Within the Helvetica Neue family, two weights can be used: Helvetica Neue Light and Helvetica Neue Bold.

When Znips London appears in a text, it should be written in lowercase with initial capitals, for example: Znips London.

Small variations in the use of the typeface will undermine the impact and consistency of the identity.

ABCDEFGHIJKLMNOPQRSTUVWXYZ
abcdefghijklmnopqrstuvwxyz
0123456789 (.,:?!#)*"\$£%"[\]&@</>

Helvetica Neue 45 Light 18pt

ABCDEFGHIJKLMNOPQRSTUVWXYZ
abcdefghijklmnopqrstuvwxyz
0123456789 (.,:?!#)"\$£%"[\]&@</>*

Helvetica Neue 45 Light Italic 18pt

ABCDEFGHIJKLMNOPQRSTUVWXYZ
abcdefghijklmnopqrstuvwxyz
0123456789 (.,:?!#)*"\$£%"[\]&@</>

Helvetica Neue 75 Bold 18pt

ABCDEFGHIJKLMNOPQRSTUVWXYZ
abcdefghijklmnopqrstuvwxyz
0123456789 (.,:?!#)*"\$£%"[\]&@</>

Helvetica Neue 75 Bold Italic 18pt

2.2 Typographic Basics

Always assess the information you are working with and establish a clear and logical hierarchy. Shown is an example of how emphasis is given through the use of contrasting weight, colour and /or typesize.

The number of type sizes and different weights used within a document should be kept to a minimum. headings and support headings should always have initial capitals in the first word.

For standard text use Helvetica Neue Light in 10 point size and with a 12.5 point line spacing. Do not use indents and not more than 12 words per line.

On formats over DIN-A4 standard text can be set in Helvetica Light 14 point with a 17 point line spacing. For technical information use Helvetica Neue Light in 7point size with an 8.5 point line spacing.

Main Heading

Support Heading

Paragraph Heading

Lorem ipsum dolor sit amet, consectetur adipiscing elit. Pellentesque eros. Suspendisse justo augue, iaculis id, tristique et, nonummy a, quam. Cras libero metus, rutrum quis, malesuada quis, euismod a, mi. Vivamus dapibus erat a enim pulvinar tempus

Paragraph Heading Two

Lorem ipsum dolor sit amet, consectetur adipiscing elit. Pellentesque eros. Suspendisse justo augue, iaculis id, tristique et, nonummy a, quam. Cras libero metus, rutrum quis, malesuada quis, euismod a, mi. Vivamus dapibus erat a enim pulvinar tempus.

Bullet Points

- Lorem ipsum dolor sit amet, consectetur adipiscing aller.
- Elitumque enim tesque eros suspendisse justo augue iaculis idque agnus madra.
- Tristique et, nonummy a, quam ras libero metupus rutrum ude quis, malesuada quis, euismod iva mus dapibus erat a enim pulvinar tempus

Stationery

The background of the page is a solid orange color. Overlaid on this is a complex pattern of thin, white, concentric arcs. These arcs are arranged in a way that they appear to be part of a series of overlapping circles or ellipses, creating a grid-like structure that is both organic and geometric. The arcs are most densely packed in the center and become more sparse towards the edges, creating a sense of depth and movement.

3.1–3.4 Stationery

It is important that the corporate identity is used consistently across all stationery. There are some simple examples shown on the next few pages. Where possible, please use the templates provided.

3.1 Business Card

Znips London

75 Wilton Road, London SW1V 1DE
Telephone: +44 (0)20 7828 6688



Shown 100%

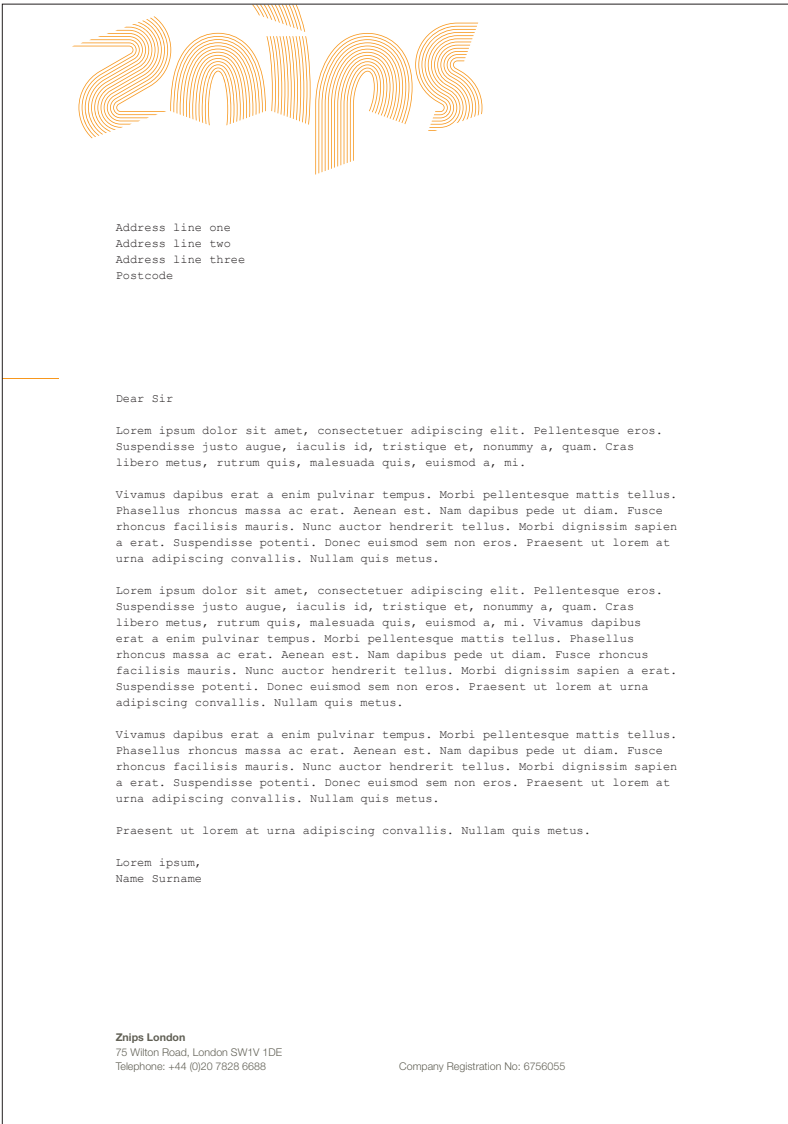

Shown 50%



Shown 50%

3.3 Compliment Slip

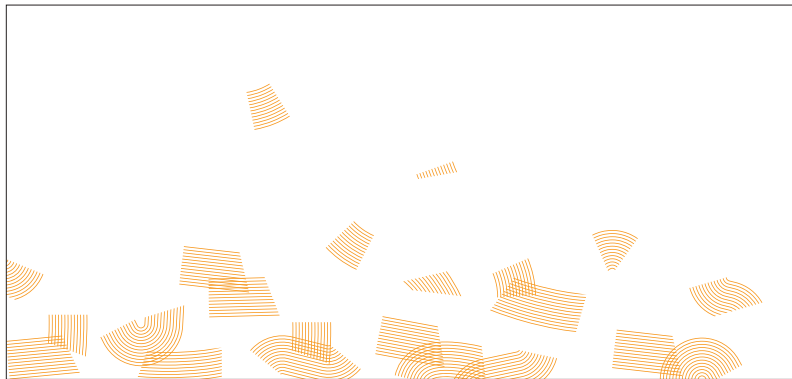
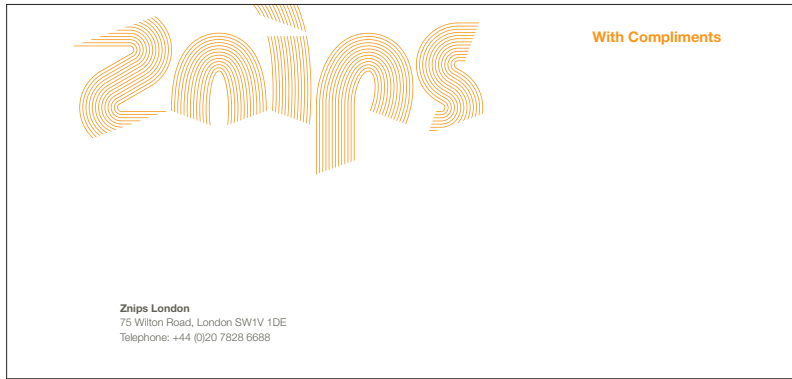

Shown 50%

3.4 Fax Sheet

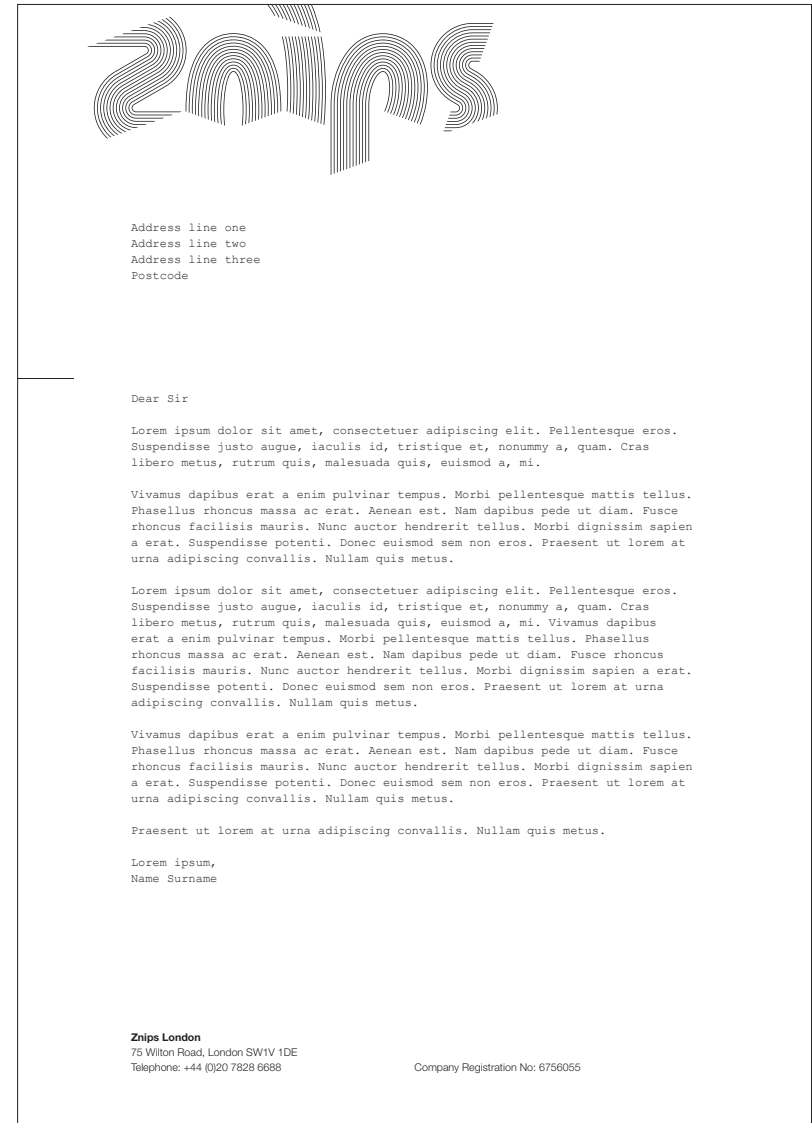

Shown 50%

Retail

The background is a solid orange color with a complex pattern of thin white lines. On the left and center, the lines are mostly vertical and slightly wavy. On the right side, there is a distinct grid pattern formed by horizontal and vertical lines. The word "Retail" is written in white, bold, sans-serif font in the upper right quadrant.

4.1 Store

The Znips store environment is a vital piece of the Znips identity. The following pages show some of the applications the Znips logo. Please contact Mind Design if you have any queries and for exact dimensions.

4.1 Signage



3D signage logo shape made from in metal and powder-coated grey/green.
Logo stripes are made in vinyl and placed onto the cut outer shape.



Znips logo in vinyl placed on a metal plate cut in the shape of the outer shape.

4.2 Window Vinyl



Frosted vinyl pattern with orange vinyl opening times.

4.3 Aprons



Credits & Support

For support and queries please contact Mind Design.

Mind Design
Unit 33a, Regent Studios
8 Andrews Road, London E8 4QN

Telephone: +44 (0)20 7254 2114
Email: info@minddesign.co.uk
www.minddesign.co.uk